

9998 OLD PLACERVILLE ROAD
 Sacramento, CA. 95827
 Phone: (916) 363-2681; Fax: (916) 363-4537
 www.claytonhomes.com www.karstenhomes.com

DRAWING
 TITLE:

SALES FLOOR PLAN

DRAWING FILE INFORMATION:

STANDARD AS OF REVISION DATE

PRODUCT: CORONADO SERIES	DESRIP.: 2446-2B	MODEL NO.: COR24462B
	SQUARE FT.: 1032/1128	DATE: 08/26/19
DRAWN BY:	SHEET: 1-A	REVISED: 05-25-23

JUL 24, 2023 - 11:56am H:\UD-HOMES\STD-2023\COR-2023\COR_24-WIDE\COR24462B.DWG

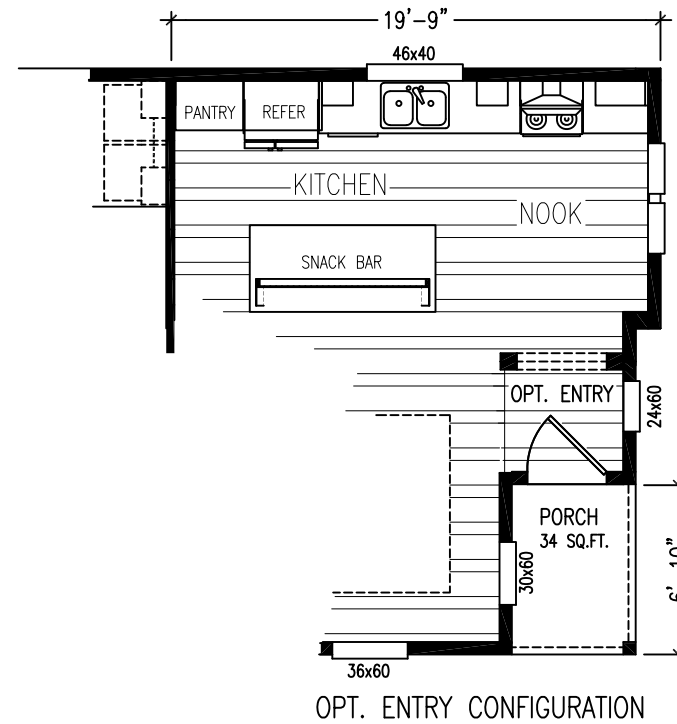
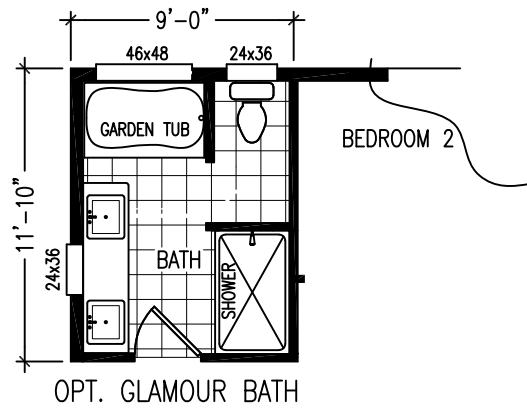

9998 OLD PLACERVILLE ROAD
Sacramento, CA. 95827
Phone: (916) 363-2681; Fax: (916) 363-4537
www.claytonhomes.com www.karstenhomes.com

DRAWING
TITLE:

OPT. SALES FLOOR PLAN

DRAWING FILE INFORMATION:

STANDARD AS OF REVISION DATE

PRODUCT:

CORONADO SERIES

DESIP.:

2446-2B

MODEL NO.:

COR24462B

SQUARE FT.:

1032/1128

DATE:

08/26/19

DRAWN BY:

SHEET:

1-B

REVISED:

09-05-19

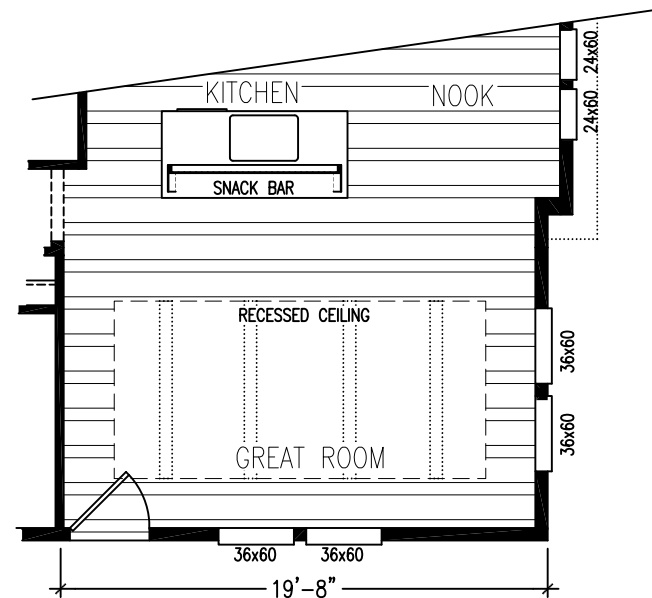

9998 OLD PLACERVILLE ROAD
 Sacramento, CA. 95827
 Phone: (916) 363-2681; Fax: (916) 363-4537
 www.claytonhomes.com www.karstenhomes.com

DRAWING
 TITLE:

OPT. SALES FLOOR PLAN

DRAWING FILE INFORMATION:

STANDARD AS OF REVISION DATE

PRODUCT: CORONADO SERIES	DESRI.: 2446-2B	MODEL NO.: COR24462B
	SQUARE FT.: 1032/1128	DATE: 08/26/19
DRAWN BY:	SHEET: 1-C	REVISED: 09-05-19

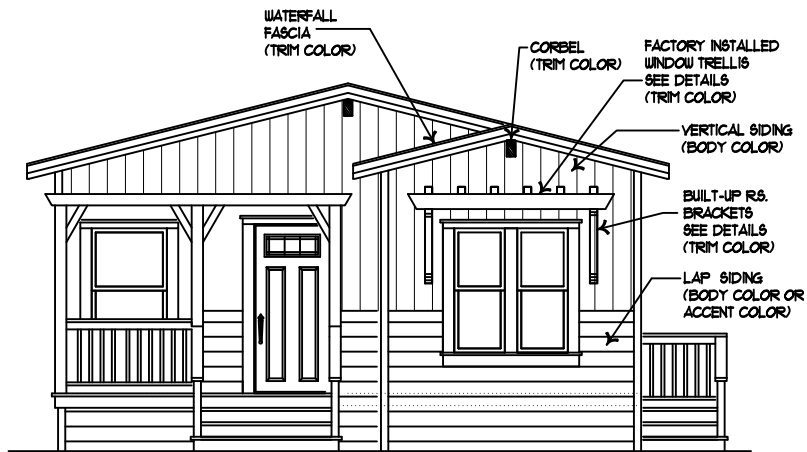

ENDWALL ELEVATION - FRONT (STD)

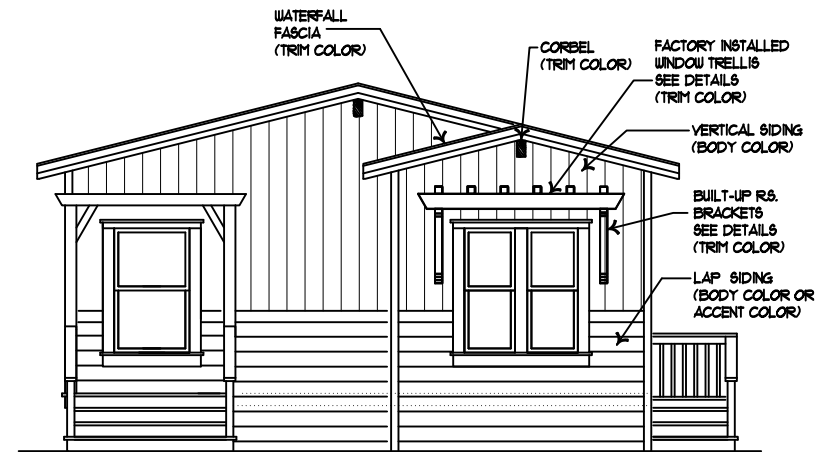

ENDWALL ELEVATION - FRONT (ALT. ENTRY)

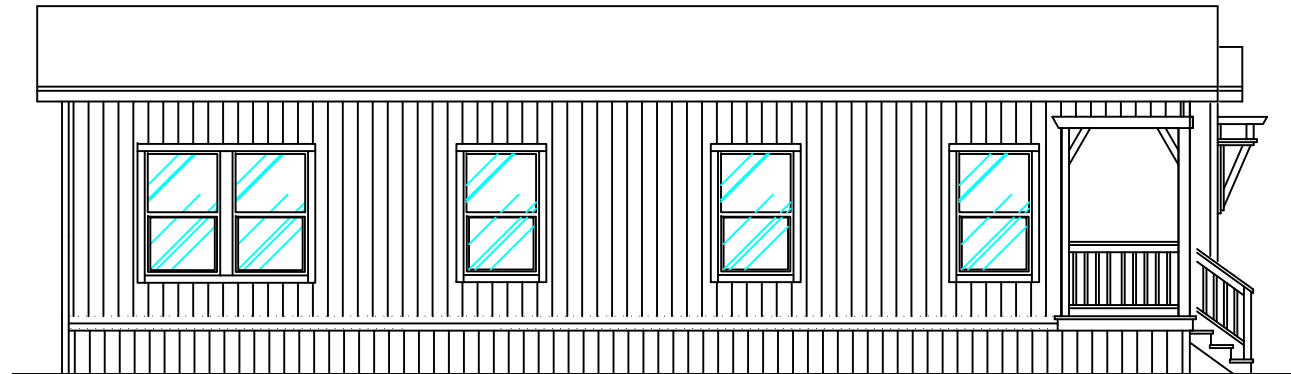

SIDEWALL ELEVATION - LEFT



NOTES:

1. 9' SIDEWALL WITH FLAT CEILING
2. ROOF PITCH 3:12

TRELLIS EXTERIOR

CMH
MANUFACTURING INC.
 9998 OLD PLACERVILLE ROAD
 Sacramento, CA. 95827
 Phone: (916) 363-2681; Fax: (916) 363-4537
 www.claytonhomes.com www.karstenhomes.com

DRAWING
 TITLE:

EXTERIOR ELEVATIONS

DRAWING FILE INFORMATION:

STANDARD AS OF REVISION DATE

PRODUCT: CORONADO SERIES	DESRIP.: 2446-2B	MODEL NO.: COR24462B
	SQUARE FT.:	DATE: 08/26/19
DRAWN BY:	SHEET: 2-A	REVISED: 08-20-13

Legend

- A - Composition Shingle Roof
- B - Hardboard 8" V-Groove - (Body Color)
- C - 1x3" Rough Sawn - (Trim Color)
- D - 1X3" Rough Sawn - (Body Color)
- E - 2x8" Rough Sawn - (Trim Color)
- F - Light

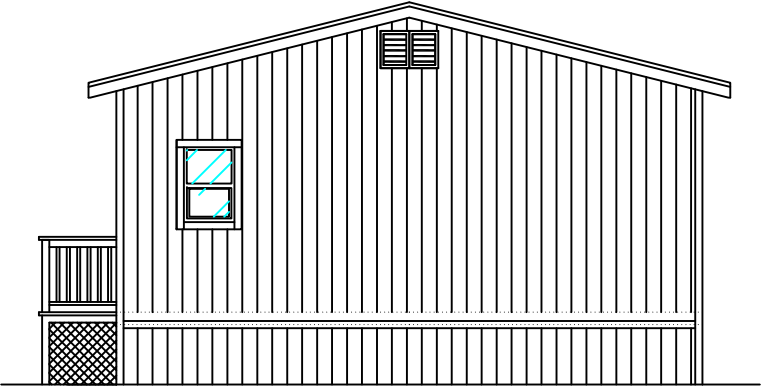

ENDWALL ELEVATION - REAR

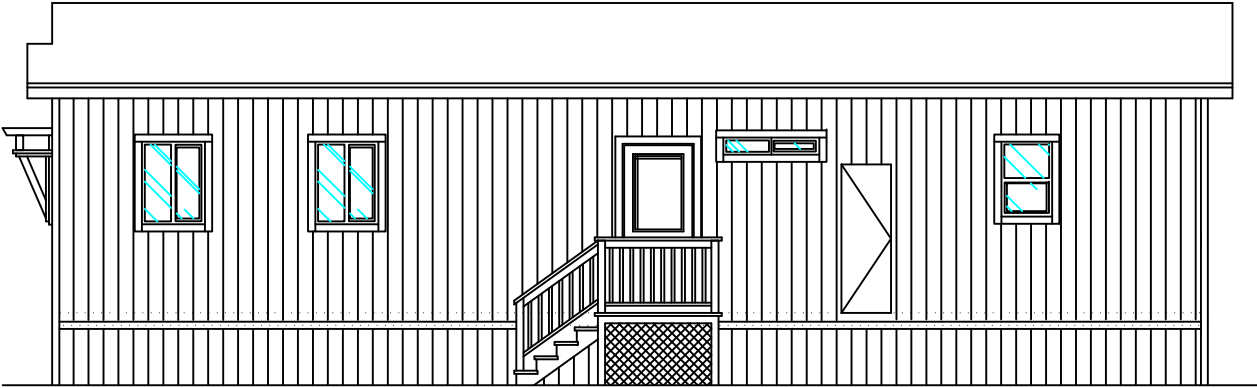

SIDEWALL ELEVATION - RIGHT



9998 OLD PLACERVILLE ROAD
 Sacramento, CA. 95827
 Phone: (916) 363-2681; Fax: (916) 363-4537
 www.claytonhomes.com www.karstenhomes.com

DRAWING
 TITLE:

EXTERIOR ELEVATIONS - 2

DRAWING FILE INFORMATION:

STANDARD AS OF REVISION DATE

PRODUCT: CORONADO SERIES	DESRIP.: 2446-2B	MODEL NO.: COR24462B
	SQUARE FT.:	DATE: 08/26/19
DRAWN BY:	SHEET: 2-B	REVISED:

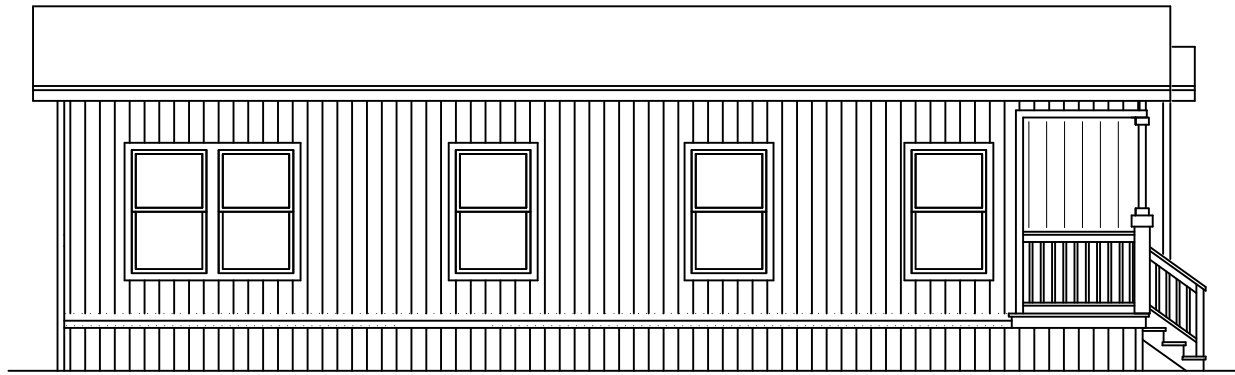

SIDEWALL ELEVATION - LEFT

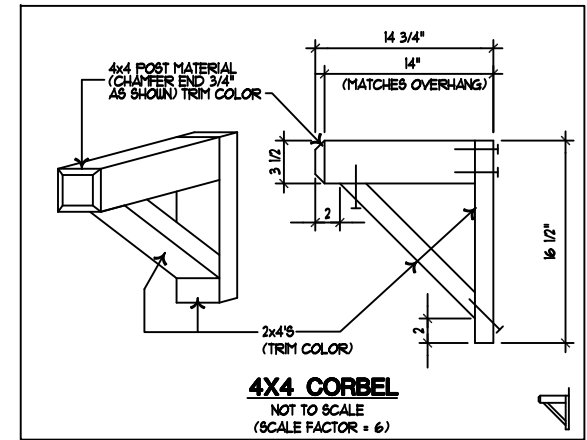

4x4 CORBEL
NOT TO SCALE
(SCALE FACTOR = 6)

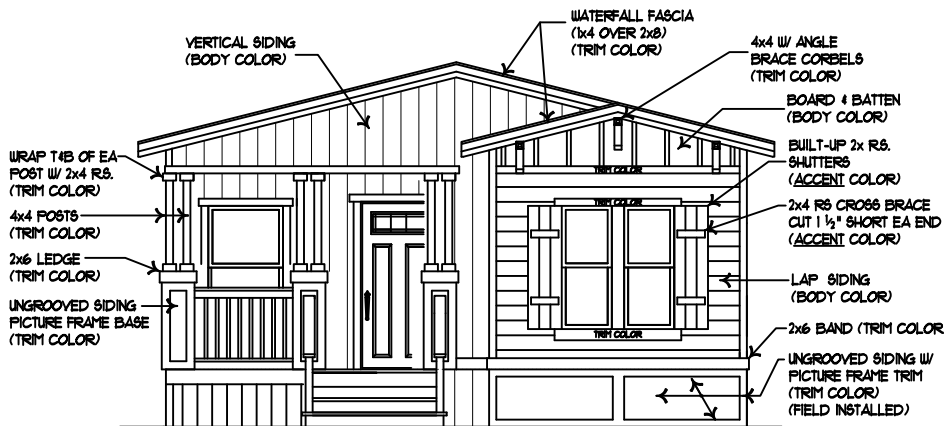

ENDWALL ELEVATION - FRONT (STD)

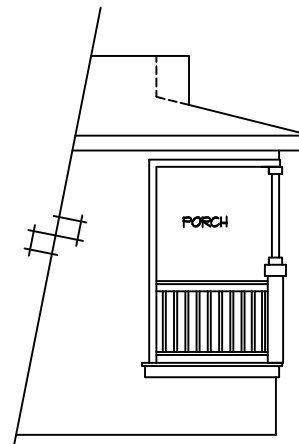

SIDE

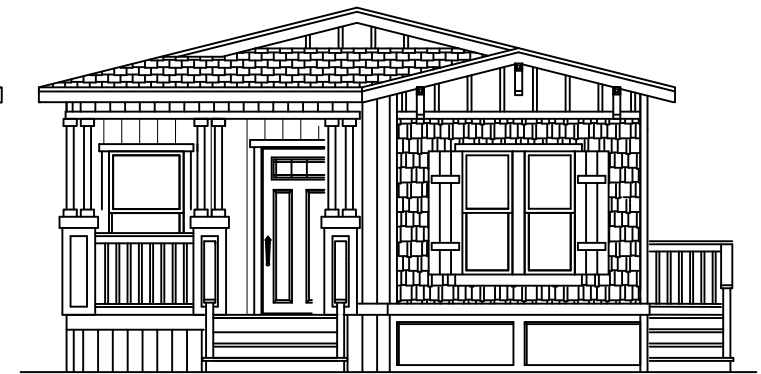

ENDWALL ELEVATION - FRONT (HIP)

**ALTERNATE PORCH HIP W/
ALTERNATE SHAKE ACCENT**

CRAFTSMAN EXTERIOR



9998 OLD PLACERVILLE ROAD
Sacramento, CA. 95827
Phone: (916) 363-2681; Fax: (916) 363-4537
www.claytonhomes.com www.karstenhomes.com

DRAWING
TITLE:

EXTERIOR ELEVATIONS-3

DRAWING FILE INFORMATION:

STANDARD AS OF REVISION DATE

PRODUCT: CORONADO SERIES	DESRIP.: 2446-2B	MODEL NO.: COR24462B
	SQUARE FT.:	DATE: 08/26/19
DRAWN BY:	SHEET: 2-C	REVISED:

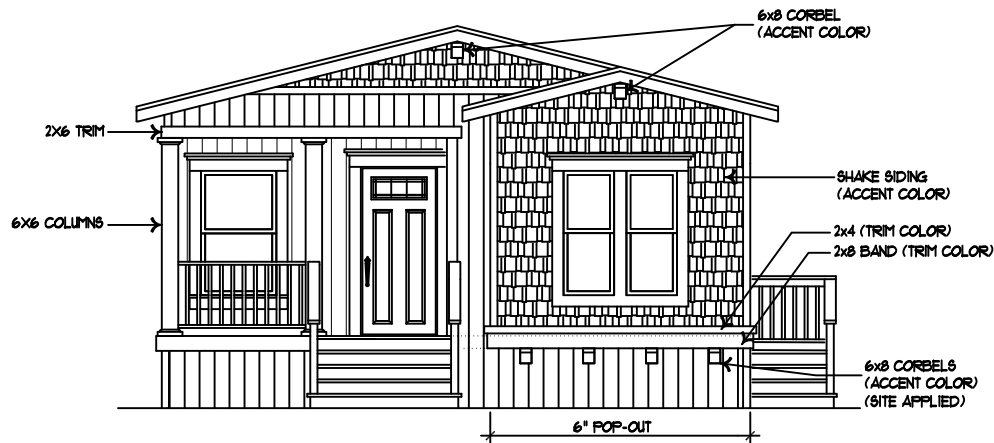

FRONT ENDWALL ELEVATION

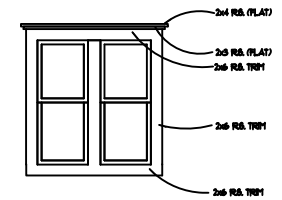

CORONADO COSTAL WINDOW TRIM DETAIL

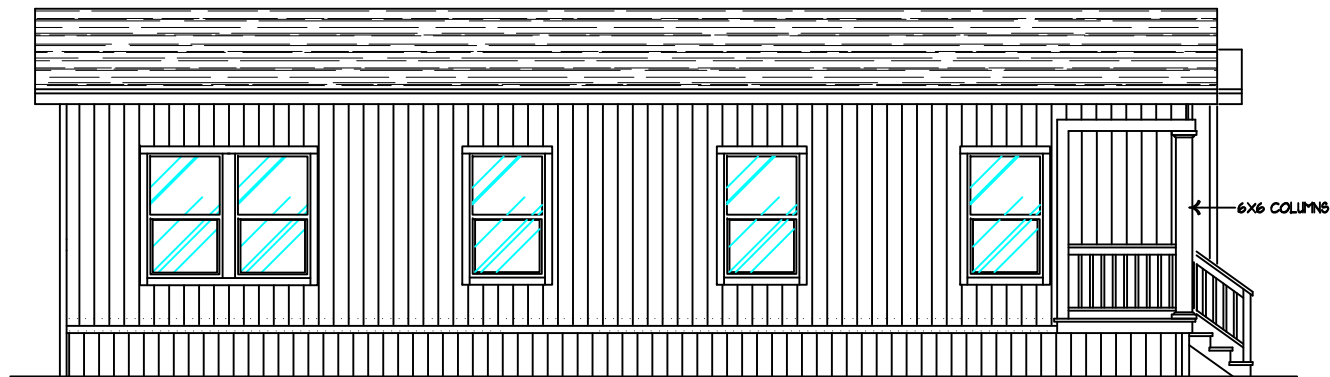

SIDEWALL ELEVATION - LEFT

COASTAL EXTERIOR



9998 OLD PLACERVILLE ROAD
 Sacramento, CA. 95827
 Phone: (916) 363-2681; Fax: (916) 363-4537
 www.claytonhomes.com www.karstenhomes.com

DRAWING
 TITLE:

FRONT ELEVATIONS-4

DRAWING FILE INFORMATION:

STANDARD AS OF REVISION DATE

PRODUCT:
 CORONADO SERIES

DESRIP.:
 2446-2B

MODEL NO.:
 COR24462B

SQUARE FT.:

DATE:
 08/26/19

DRAWN BY:

SHEET:

2-D

REVISED:

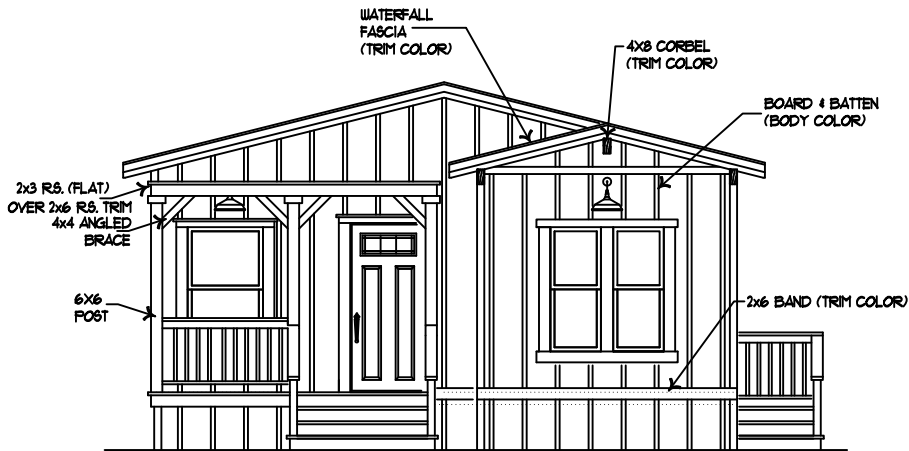

Front Elevation FARMHOUSE

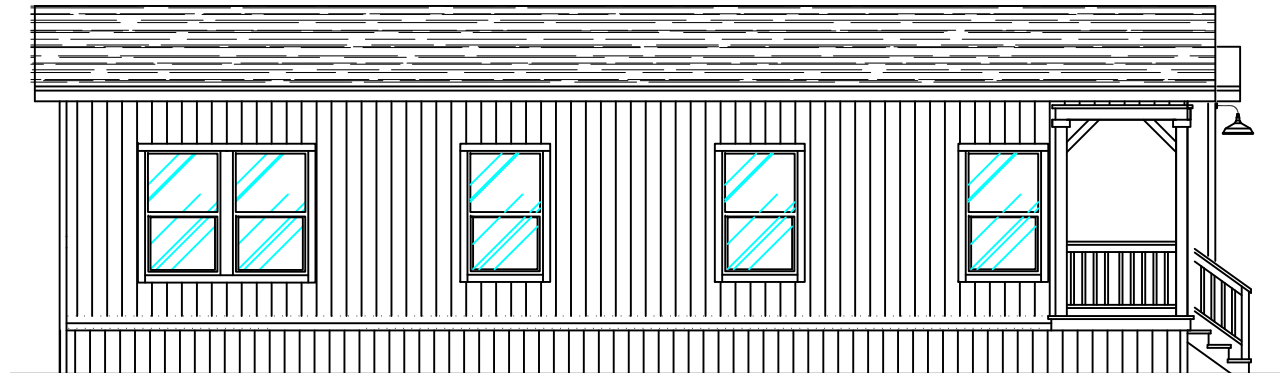

Left Side Elevation (FARMHOUSE)

FARMHOUSE EXTERIOR



9998 OLD PLACERVILLE ROAD
 Sacramento, CA. 95827
 Phone: (916) 363-2681; Fax: (916) 363-4537
 www.claytonhomes.com www.karstenhomes.com

DRAWING
 TITLE:

EXTERIOR ELEVATIONS-5

DRAWING FILE INFORMATION:

STANDARD AS OF REVISION DATE

PRODUCT: CORONADO SERIES	DESRI.P.: 2446-2B	MODEL NO.: COR24462B
	SQUARE FT.:	DATE: 08/26/19
DRAWN BY:	SHEET: 2-E	REVISED: